

Package Contents: Switch, Power cord, QIG, Screwdriver

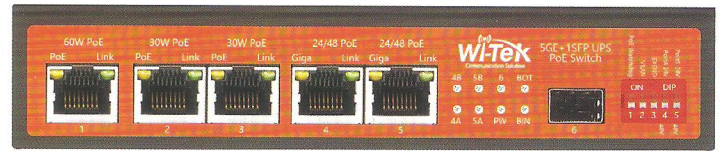

Port	MAX power	Voltage	Application	PIN
Port 1	60W	802.3af/at/bt 48V	Dome camera	1,2,4,5+ 3,6,7,8-
Port 2-3	30W	802.3af/at 48V	Bullet camera	1,2+ 3,6-
Port 4-5	30W	Passive 24V/802.3af/at 48V	Wireless Transmitter	1,2+ 3,6- or 4,5+ 7,8-

LED Explanation

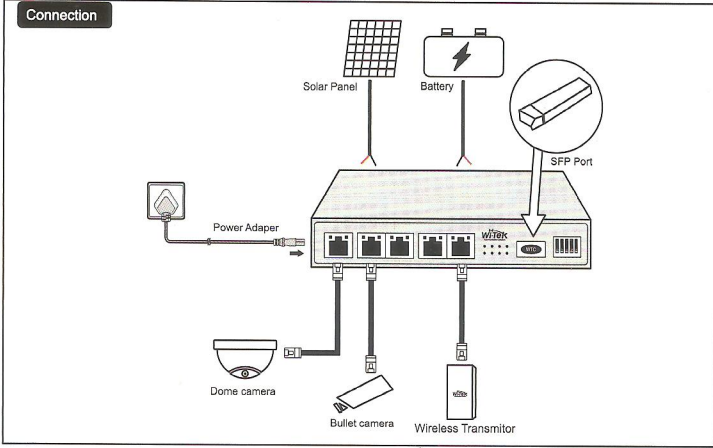
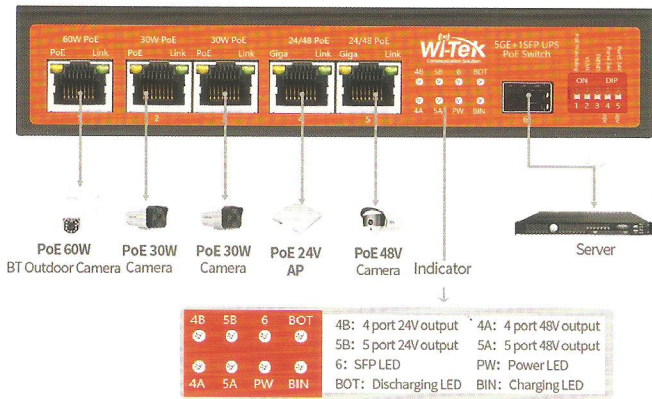

Back panel

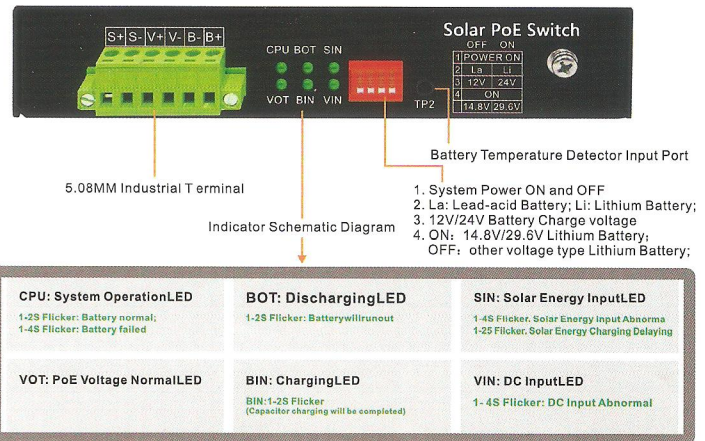

Terminal Connection Description

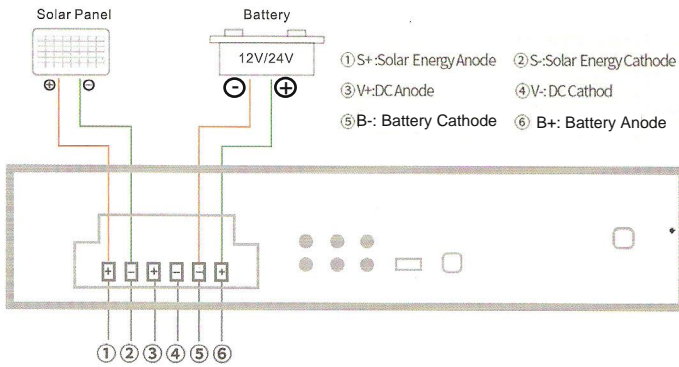

If the switch is Powered by AC. Please screw the positive wire to the V+ pore and negative wire to V- pore.

If the switch is Powered by solar. Please screw the positive wire of solar panel to S+ pore and negative wire to S- pore. If you also want to connect battery to it, please screw the positive wire of battery to B+ and negative wire to B-.

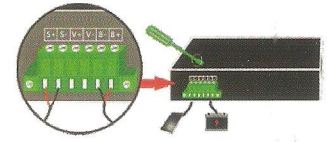
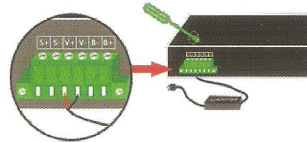

Note: The switch can be powered by both AC and solar panel.

The PIN definition of WI-Tek PoE switch

PINS	T568A Color	T568B Color	Passive 24V 100M	802.3af/at 48V 100M	Passive 24V 1000M	802.3af/at 48V 1000M
1	White/green stripe	White/orange stripe	Rx+	Rx+ DC+	TxRx A+	TxRx A+ DC+
2	green solid	orange solid	Rx-	Rx- DC+	TxRx A-	TxRx A- DC+
3	White/orange stripe	White/green stripe	Tx+	Tx + DC-	TxRx B+	TxRx B- DC-
4	blue solid	blue solid	DC+	Unused	TxRx C+ DC+	TxBx C+
5	White/blue stripe	White/blue stripe	DC+	Unused	TxRx C- DC+	TxRx C-
6	orange solid	green solid	Tx-	Tx -DC-	TxRx B-	TxRx B- DC-
7	White/brown stripe	White/brown stripe	DC-	Unused	TxRx D+ DC-	TxRx D+
8	brown solid	brown solid	DC-	Unused	TxRx C- DC-	TxRx D-

Warranty Card

Username	
Address	
Telephone No.	
Purchase Shop	
Purchase Address	
Product Model No.	
Purchase Time	
Serial No.	
Dealer Signature	

- If the product defects within three months after purchase, we will provide you a new product of the same model.
- If the product defects within the three-year warranty period, we will provide the professional maintenance service.
- Proof of purchase and a complete product serial number are required to receive any services guaranteed as part of the limited warranty.
- Any other defects that are not caused by workmanship or product quality, such as natural disaster, water damage, extreme thermal or environmental conditions, sticker damaged, warranty card losing will disqualify the product from limited warranty.